



(An ISO 9001 : 2015 Co.)



# AKSHRA INDUSTRIES

(An ISO 9001 : 2015 Co.)

Mfrs. of : Plastic Crates, Bins, Pallets, PP Boxes & Racks

## Factory:

Plot No. 3, Gadpuri Industrial

Area, Near By NH-2,

Faridabad - 121004, Haryana

Mobile : +91-9821733080, 9311699257

E-mail : [industriesakshra@gmail.com](mailto:industriesakshra@gmail.com)

## Office :

Plot No. 03, Rajesh Complex Unity City

Chauraha, Kanchana Bihar Marg,

Lucknow-226022





With a comprehensive study about the need of a customer, related for material handling, we have created a widest array of crates catering to the specification of customers with proper technical know how & quality control. We have conjured the best grade material & design to maintain the quality standard in the market. We are well aware of the competitive market & our strongest USP is our wide product range. Regarding quality, it is needless to say that it is weatherproof & UV resistant with a brutal characteristic to withstand crudest of handling.

The areas where our product could be most effective are industries like Beverages, Dairy, Fruit & Vegetable, Bakery, Fisheries, Automotives, Electronics, Caterers, Garments, Softdrinks, Cold storages, FMCG, Retailing,



Textile and other industries where storage, stacking and nesting is required.

We have been consistently growing since 40 years in the plastic industry. Our products have a global presence. With advance technology, we enthrall our clientele by meeting with their stupendous demand in time.

APPLICATIONS  
APPLICATIONS  
APPLICATIONS  
APPLICATIONS



40 years of concrete experience  
"The name you can trust"



- Latest Machines
- Latest Moulds
- Advance Technology

APPLICATIONS  
APPLICATIONS  
APPLICATIONS  
APPLICATIONS



# APPLICATIONS



BAKERY



ICE - CREAM  
INDUSTRY



ELECTRONIC



FISHING



DAIRY  
INDUSTRY



FRUITS & VEGETABLES



GARMENT



HOTEL  
INDUSTRY

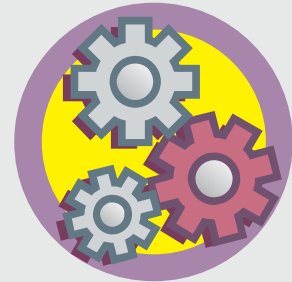

AUTOMOBILES



LIQUOR & WINE



RETAIL OUTLETS

## ABBR. USED FOR CRATES

CL : CLOSE WITH HANDLE

CC : COMPLETE CLOSED

SP : SIDE PERFORATED & BOTTOM CLOSED

TP : TOTALLY PERFORATED

TPC : TOTALLY PERFORATED WITH CUT

FB : FLAT BOTTOM

FT : FLAT TOP

WOH : WITHOUT HANDLE

WH : WITH HANDLE

RCR : ROUND CRATE  
WITH ROPE

RCH : ROUND CRATE WITH  
HANDLE

RCC : ROUND CRATE CLOSED  
WITHOUT HANDLE

LW : LOW WEIGHT

HW : HEAVY WEIGHT

MW : MEDIUM WEIGHT

1 inch = 25.4 mm

(all dimensions are approximate only)

# SERIES 300-200/400-300



**MODEL NO. : 32065CC**

DIMENSIONS:

O.D. 300(L) X 200(B) X 65(H)mm

I. D. 265(L) X 165(B) X 60(H)mm

CAPACITY- 2 LITRES



**MODEL NO.: 32100 CC**

DIMENSIONS:

O.D. 300 (L) X 200 (B) X 100 (H) mm

I.D. 265 (L) X 165 (B) X 95 (H) mm

CAPACITY - 4 LITRES



**MODEL NO.: 32150 CC**

DIMENSIONS:

O.D. 300 (L) X 200 (B) X 150 (H) mm

I.D. 265 (L) X 165 (B) X 145 (H) mm

CAPACITY - 6 LITRES



**LID : 3200**

O.D. 300(L) X 200(B) X 24(H) mm



**MODEL NO.: 32200 CC**

DIMENSIONS:

O.D. 300 (L) X 200 (B) X 200 (H) mm

I.D. 265 (L) X 165 (B) X 195 (H) mm

CAPACITY - 8 LITRES



**MODEL NO.: 43065 CC**

DIMENSIONS:

O.D. 400 (L) X 300 (B) X 065 (H) mm

I.D. 360 (L) X 260 (B) X 60 (H) mm

CAPACITY - 5 LITRES



**MODEL NO. : 43080CC**

DIMENSIONS:

O.D. 400(L) X 300(B) X 80(H)mm

I. D. 360(L) X 260(B) X 75(H)mm

CAPACITY- 6 LITRES



**MODEL NO. : 43090CC**

DIMENSIONS:

O.D. 400(L) X 300(B) X 90(H)mm

I. D. 360(L) X 260(B) X 85(H)mm

CAPACITY- 7 LITRES



**MODEL NO.: 43100 CC**

DIMENSIONS:

O.D. 400 (L) X 300 (B) X 100 (H) mm

I.D. 360 (L) X 260 (B) X 96(H) mm

CAPACITY - 9 LITRES

FLAT BOTTOM AVAILABLE IN 300-200 & 400-300 SERIES

## SERIES 400-300



**MODEL NO.: 43120 CC**  
DIMENSIONS:  
O.D. 400 (L) X 300 (B) X 120 (H) mm  
I.D. 360 (L) X 260 (B) X 115 (H) mm  
CAPACITY - 10 LITRES



**MODEL NO.: 43175 CC**  
DIMENSIONS:  
O.D. 400 (L) X 300 (B) X 175 (H) mm  
I.D. 360 (L) X 260 (B) X 170 (H) mm  
CAPACITY - 15 LITRES



**MODEL NO.: 43240 CC**  
DIMENSIONS:  
O.D. 400 (L) X 300 (B) X 240 (H) mm  
I.D. 360 (L) X 260 (B) X 235 (H) mm  
CAPACITY - 22 LITRES



**LID : 4300**  
O.D. 400(L) X 300(B) X 24(H) mm



**MODEL NO.: 43150 CC**  
DIMENSIONS:  
O.D. 400 (L) X 300 (B) X 150 (H) mm  
I.D. 360 (L) X 260 (B) X 145(H) mm  
CAPACITY - 13 LITRES



**MODEL NO.: 43220 CC**  
DIMENSIONS:  
O.D. 400 (L) X 300 (B) X 220 (H) mm  
I.D. 360 (L) X 260 (B) X 215(H) mm  
CAPACITY - 20 LITRES



**MODEL NO.: 43275 CC**  
DIMENSIONS:  
O.D. 400 (L) X 300 (B) X 275 (H) mm  
I.D. 360 (L) X 260 (B) X 270 (H) mm  
CAPACITY - 25 LITRES



**MODEL NO.: 43320 CC**  
DIMENSIONS:  
O.D. 400 (L) X 300 (B) X 320 (H) mm  
I.D. 360 (L) X 260 (B) X 315 (H) mm  
CAPACITY - 30 LITRES

**FLAT BOTTOM AVAILABLE IN 400-300 SERIES**



**MODEL NO.: 53100 CL/CC**  
DIMENSIONS:  
O.D. 500 (L) X 325 (B) X 100 (H) mm  
I.D. 468 (L) X 292 (B) X 92 (H) mm  
CAPACITY - 13 LITRES



**MODEL NO.: 53150 CL/CC**  
DIMENSIONS:  
O.D. 500 (L) X 325 (B) X 150 (H) mm  
I.D. 468 (L) X 292 (B) X 142 (H) mm  
CAPACITY - 19 LITRES



**MODEL NO.: 53200 CL/CC**  
DIMENSIONS:  
O.D. 500 (L) X 325 (B) X 200 (H) mm  
I.D. 468 (L) X 292 (B) X 192 (H) mm  
CAPACITY - 26 LITRES



358/-

**MODEL NO. : 53200SP**  
DIMENSIONS:  
O.D. 500(L) X 325(B) X 200(H)mm  
I. D. 468(L) X 295(B) X 192(H)mm  
CAPACITY- 26 LITRES



**MODEL NO.: 53360 CL/CC**  
DIMENSIONS:  
O.D. 500 (L) X 325 (B) X 360 (H) mm  
I.D. 468 (L) X 292 (B) X 352 (H) mm  
CAPACITY - 50 LITRES



**MODEL NO.: 53250 CL/CC**  
DIMENSIONS:  
O.D. 500 (L) X 325 (B) X 250 (H) mm  
I.D. 468 (L) X 292 (B) X 242 (H) mm  
CAPACITY - 33 LITRES



**LID : 5300**  
O.D. 500(L) X 325(B) X 24(H) mm

FLAT BOTTOM AVAILABLE IN 500-325 SERIES

# SERIES 600-400



**LID : 6400**  
O.D. 600(L) X 400(B) X 24(H) mm



**MODEL NO.: 64080 CC**  
DIMENSIONS:  
O.D. 600 (L) X 400 (B) X 80 (H) mm  
I.D. 565 (L) X 365 (B) X 75 (H) mm  
CAPACITY - 12 LITRES



**MODEL NO.: 64120 CL**  
DIMENSIONS:  
O.D. 600 (L) X 400 (B) X 120 (H) mm  
I.D. 565 (L) X 365 (B) X 113 (H) mm  
CAPACITY - 22 LITRES



**MODEL NO.: 64080 SP**  
DIMENSIONS:  
O.D. 600 (L) X 400 (B) X 80 (H) mm  
I.D. 565 (L) X 365 (B) X 75 (H) mm  
CAPACITY -12 LITRES



**MODEL NO.: 64120 SP**  
DIMENSIONS:  
O.D. 600 (L) X 400 (B) X 120 (H) mm  
I.D. 565 (L) X 365 (B) X 113 (H) mm  
CAPACITY - 22 LITRES



**MODEL NO.: 64080 TP**  
DIMENSIONS:  
O.D. 600 (L) X 400 (B) X 80 (H) mm  
I.D. 565 (L) X 365 (B) X 75 (H) mm  
CAPACITY -12 LITRES



**MODEL NO.: 64120 TP**  
DIMENSIONS:  
O.D. 600 (L) X 400 (B) X 120 (H) mm  
I.D. 565 (L) X 365 (B) X 113 (H) mm  
CAPACITY - 22 LITRES

FLAT BOTTOM AVAILABLE IN 600-400 SERIES

**SERIES 600-400**



**MODEL NO.: 64180 CL**  
DIMENSIONS:  
O.D. 600 (L) X 400 (B) X 180 (H) mm  
I.D. 565 (L) X 365 (B) X 170 (H) mm  
CAPACITY - 38 LITRES



**MODEL NO.: 64225 CL**  
DIMENSIONS:  
O.D. 600 (L) X 400 (B) X 225 (H) mm  
I.D. 565 (L) X 365 (B) X 215 (H) mm  
CAPACITY - 45 LITRES



**MODEL NO.: 64180 SP**  
DIMENSIONS:  
O.D. 600 (L) X 400 (B) X 180 (H) mm  
I.D. 565 (L) X 365 (B) X 170 (H) mm  
CAPACITY - 38 LITRES



**MODEL NO.: 64225 SP**  
DIMENSIONS:  
O.D. 600 (L) X 400 (B) X 225 (H) mm  
I.D. 565 (L) X 365 (B) X 215 (H) mm  
CAPACITY - 45 LITRES



**MODEL NO.: 64180 TP**  
DIMENSIONS:  
O.D. 600 (L) X 400 (B) X 180 (H) mm  
I.D. 565 (L) X 365 (B) X 170 (H) mm  
CAPACITY - 38 LITRES



DIMENSIONS:  
O.D. 600 (L) X 400 (B) X 225 (H) mm  
I.D. 565 (L) X 365 (B) X 215 (H) mm  
CAPACITY - 45 LITRES

**FLAT BOTTOM AVAILABLE IN 600-400 SERIES**

## SERIES 600-400



**MODEL NO.: 64425 CL**

**DIMENSIONS:**

O.D. 600 (L) X 400 (B) X 425 (H) mm

I.D. 565 (L) X 365 (B) X 415 (H) mm

**CAPACITY - 87 LITRES**



**DIMENSIONS:**

O.D. 600 (L) X 400 (B) X 485 (H) mm

I.D. 565 (L) X 365 (B) X 475 (H) mm

**CAPACITY - 102 LITRES**



**MODEL NO.: 64425 SP**

**DIMENSIONS:**

O.D. 600 (L) X 400 (B) X 425 (H) mm

I.D. 565 (L) X 365 (B) X 415 (H) mm

**CAPACITY - 87 LITRES**



**MODEL NO.: 64485 TP**

**DIMENSIONS:**

O.D. 600 (L) X 400 (B) X 485 (H) mm

I.D. 565 (L) X 365 (B) X 475 (H) mm

**CAPACITY - 102 LITRES**



**MODEL NO.: 64425 TP**

**DIMENSIONS:**

O.D. 600 (L) X 400 (B) X 425 (H) mm

I.D. 565 (L) X 365 (B) X 415 (H) mm

**CAPACITY - 87 LITRES**



**MODEL NO.: 64485 TP**

**DIMENSIONS:**

O.D. 600 (L) X 400 (B) X 485 (H) mm

I.D. 565 (L) X 365 (B) X 475 (H) mm

**CAPACITY - 102 LITRES**

**FLAT BOTTOM AVAILABLE IN 600-400 SERIES**



**MODEL NO.: 53200 TP**  
 DIMENSIONS:  
 O.D. 500 (L) X 325 (B) X 200 (H) mm  
 I.D. 468 (L) X 292 (B) X 192 (H) mm  
 CAPACITY - 26 LITRES



**MODEL NO.: 2715 TPC**  
 DIMENSIONS:  
 O.D. 400 (L) X 325 (B) X 150 (H) mm  
 I.D. 373 (L) X 300 (B) X 130 (H) mm  
 CAPACITY - 17 LITRES



**MODEL NO.: 2725 TPC**  
 DIMENSIONS:  
 O.D. 400 (L) X 325 (B) X 250 (H) mm  
 I.D. 365 (L) X 290 (B) X 245(H) mm  
 CAPACITY - 22 LITRES



**MODEL NO.: 2725 TP**  
 DIMENSIONS:  
 O.D. 400 (L) X 325 (B) X 250 (H) mm  
 I.D. 365 (L) X 290 (B) X 245(H) mm  
 CAPACITY - 26 LITRES



**MODEL NO.: 2727 TPC**  
 DIMENSIONS:  
 O.D. 400 (L) X 325 (B) X 270 (H) mm  
 I.D. 365 (L) X 290 (B) X 265(H) mm  
 CAPACITY - 24 LITRES



**MODEL NO.: 2727 TP**  
 DIMENSIONS:  
 O.D. 400 (L) X 325 (B) X 270 (H) mm  
 I.D. 365 (L) X 290 (B) X 265(H) mm  
 CAPACITY - 28 LITRES

## DAIRY CRATES



**MODEL NO. 4737163A**  
**TUB POUCH CRATE WITH PARTITION**  
DIMENSIONS:  
O.D. 470 (L) X 378 (B) X 163 (H) mm  
I.D. 427 (L) X 335 (B) X 148 (H) mm  
( FOR 12 POUCHES OF 1 LITRE )  
CAPACITY - 12 LITRES



**MODEL NO. 4737163B**  
**TUB POUCH CRATE WITH PARTITION**  
DIMENSIONS:  
O.D. 470 (L) X 378 (B) X 163 (H) mm  
I.D. 427 (L) X 335 (B) X 148 (H) mm  
( FOR 12 POUCHES OF 1 LITRE )  
CAPACITY - 12 LITRES



**MODEL NO. 4737168B**  
**TUB POUCH CRATE WITH PARTITION**  
DIMENSIONS:  
O.D. 470 (L) X 378 (B) X 168 (H) mm  
I.D. 427 (L) X 335 (B) X 155 (H) mm  
( FOR 12 POUCHES OF 1 LITRE )  
CAPACITY - 12 LITRES



**MODEL NO. : 6545210 CL FB**  
DIMENSIONS:  
O.D. 650(L) X 450(B) X 210(H)mm  
I. D. 610(L) X 410(B) X 195(H)mm  
CAPACITY- 49 LITRES



**MODEL NO. : 6545210 CL**  
DIMENSIONS:  
O.D. 650(L) X 450(B) X 210(H)mm  
I. D. 610(L) X 410(B) X 195(H)mm  
CAPACITY- 49 LITRES



**MODEL NO. : 6545210 TP**  
DIMENSIONS:  
O.D. 650(L) X 450(B) X 210(H)mm  
I. D. 610(L) X 410(B) X 195(H)mm  
CAPACITY- 49 LITRES



**MODEL NO. : 6545210 SP**  
DIMENSIONS:  
O.D. 650(L) X 450(B) X 210(H)mm  
I. D. 610(L) X 410(B) X 195(H)mm  
CAPACITY- 49 LITRES

# HEAVY DUTY JUMBO CRATES



**LID : 65450**  
O.D. 650 (L) X 450(B) X 24(H) mm

SPECIALLY FOR BREAD INDUSTRIES



**MODEL NO.: 6545325 TP**  
DIMENSIONS:  
O.D. 650 (L) X 450 (B) X 325 (H) mm  
I.D. 610 (L) X 410 (B) X 315 (H) mm  
CAPACITY - 85 LITRES



**MODEL NO.: 6545315 CL/CC**  
DIMENSIONS:  
O.D. 650 (L) X 450 (B) X 315 (H) mm  
I.D. 610 (L) X 410 (B) X 305 (H) mm  
CAPACITY - 75 LITRES



**MODEL NO.: 6545325 CL**  
DIMENSIONS:  
O.D. 650 (L) X 450 (B) X 325 (H) mm  
I.D. 610 (L) X 410 (B) X 315 (H) mm  
CAPACITY - 85 LITRES

SPECIALLY FOR BREAD INDUSTRIES



**MODEL NO.: 6545325 SP**  
DIMENSIONS:  
O.D. 650 (L) X 450 (B) X 325 (H) mm  
I.D. 610 (L) X 410 (B) X 315 (H) mm  
CAPACITY - 85 LITRES

FLAT BOTTOM AVAILABLE

## MAHA JUMBO CRATES



**MODEL NO. : 6545485 CL**

**DIMENSIONS:**

O.D. 650(L) X 450(B) X 485(H)mm

I. D. 615(L) X 405 (B) X 468(H)mm

**CAPACITY-120 LITRES**



**MODEL NO. : 6545485 SP**

**DIMENSIONS:**

O.D. 650(L) X 450(B) X 485(H)mm

I. D. 615(L) X 405 (B) X 468(H)mm

**CAPACITY-120 LITRES**



**MODEL NO. : 6545485 TP**

**DIMENSIONS:**

O.D. 650(L) X 450(B) X 485(H)mm

I. D. 615(L) X 405 (B) X 468(H)mm

**CAPACITY-120 LITRES**

## SUPER JUMBO CRATES



**SUPER JUMBO LID**  
DIMENSIONS:  
O.D. 809(L) X 570(B) X 20(H)mm



**MODEL NO. : 857425 CL**  
DIMENSIONS:  
O.D. 809(L) X 570(B) X 425(H)mm  
I. D. 760(L) X 538 (B) X 405(H)mm  
CAPACITY-183 LITRES



**Super Jumbo With Wheel**  
**Available In SP.TP.CL.**



**MODEL NO. : 857425 TP**  
DIMENSIONS:  
O.D. 809(L) X 570(B) X 425(H)mm  
I. D. 760(L) X 538 (B) X 405(H)mm  
CAPACITY-183 LITRES



**MODEL NO. : 857425 SP**  
DIMENSIONS:  
O.D. 809(L) X 570(B) X 425(H)mm  
I. D. 760(L) X 538 (B) X 405(H)mm  
CAPACITY-183 LITRES

**Wheel Available in all 3 Variants**

# FABRICATED CRATES



# FABRICATED CRATES



Tailor made partitions can be made according to your specification.

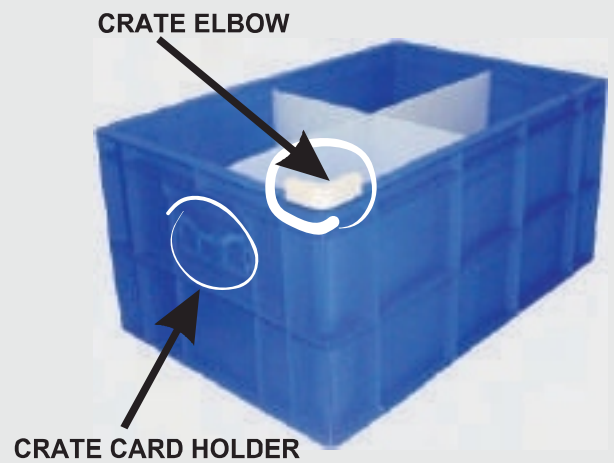

# FPO STORAGE BINS



**CRATE - 5**  
O. D. 165mm(L) X 114mm(B) X 78mm (H)



**CRATE - 15 N**  
O. D. 185mm(L) X 115mm(B) X 90mm (H)



**CRATE - 15**  
O. D. 170mm(L) X 120mm(B) X 85mm (H)



**CRATE - 20**  
O. D. 215mm(L) X 160mm(B) X 105mm (H)



**CRATE - 25**  
O. D. 225mm(L) X 150mm(B) X 125mm (H)



**CRATE - 35**  
O. D. 295mm(L) X 210mm(B) X 160mm (H)



**CRATE - 45**  
O. D. 350mm(L) X 215mm(B) X 200mm (H)



**CRATE - 50**  
O. D. 510mm(L) X 307mm(B) X 198mm (H)

# WHEEL WASTE BIN



## Available Colours



₹

120 LTR

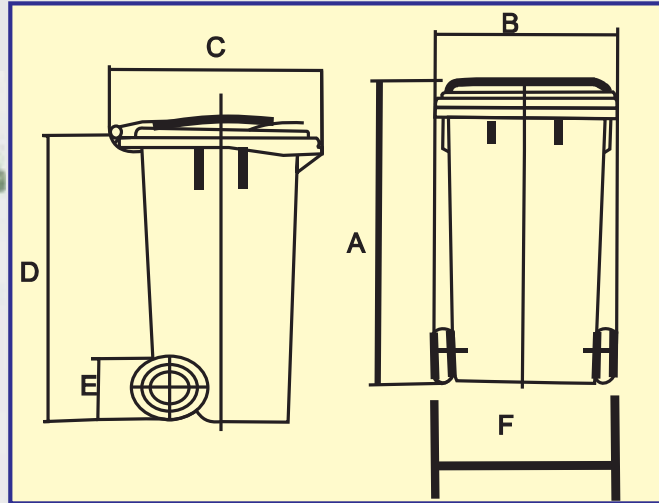

₹

Model	120	240
App Volume Ltr	120	240
Article Wt. (kgs)	7.5	12.1
useful load (kgs)	60	100
A-Overall Height(mm)	980	1075
B-Overall width(mm)	490	580
C- Overall Depth(mm)	550	740
D- Upper Edge(mm)	910	1000
E-Wheel Dia (o)(mm)	200	200
F- Wheel to Wheel distance(mm)	470	570

All the dimensions, capacity & weight are approximate & only for reference.  
 \* Subject to technical modification  
 \* Container according to EN standards



AVAILABLE WITH PEDAL





60 LTR. WASTE BIN WITH DOME LID



80 LTR. WASTE BIN WITH DOME LID



110 LTR. WASTE BIN WITH DOME LID

MODEL	80	110
App Volume (Ltrs)	80	110
Useful Load (kgs)	45	55
A Over all Height (mm)	900	940
B Over all Width (mm)	430	500
B Over Depth (mm)	430	500
D Upper Edge (mm)	695	695
FxC Window Size (mm)	265 x 135	340 x 160

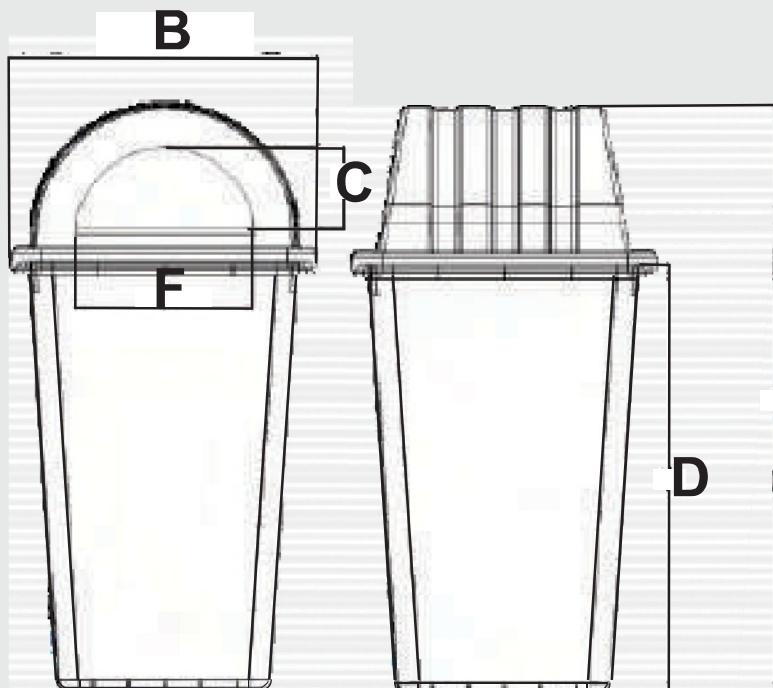

120 LTR. WHEEL WASTE BIN WITH DOME LID

All the dimensions, capacity & weight are approximate & only for reference.

\* Subject to technical modification

\* Container according to EN standards

# PALLETS



## MODEL NO. 121015 MW

**TOP**

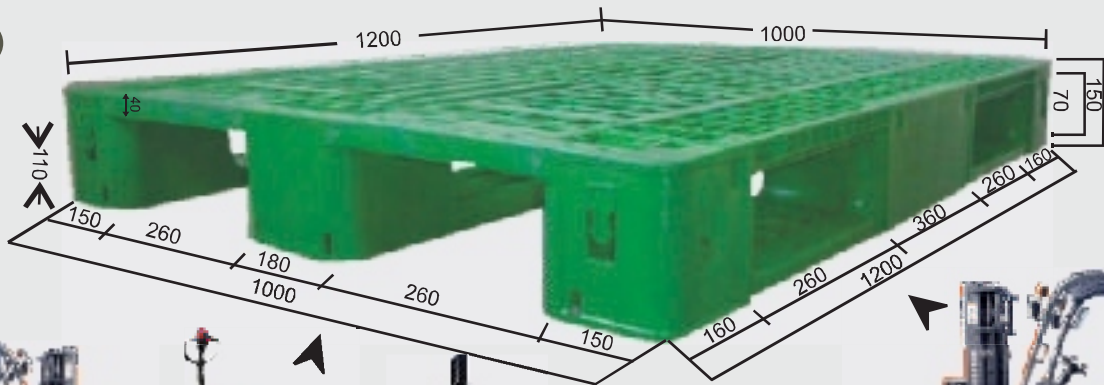

Forklift



Hand Pallet Truck



Stacker



Forklift

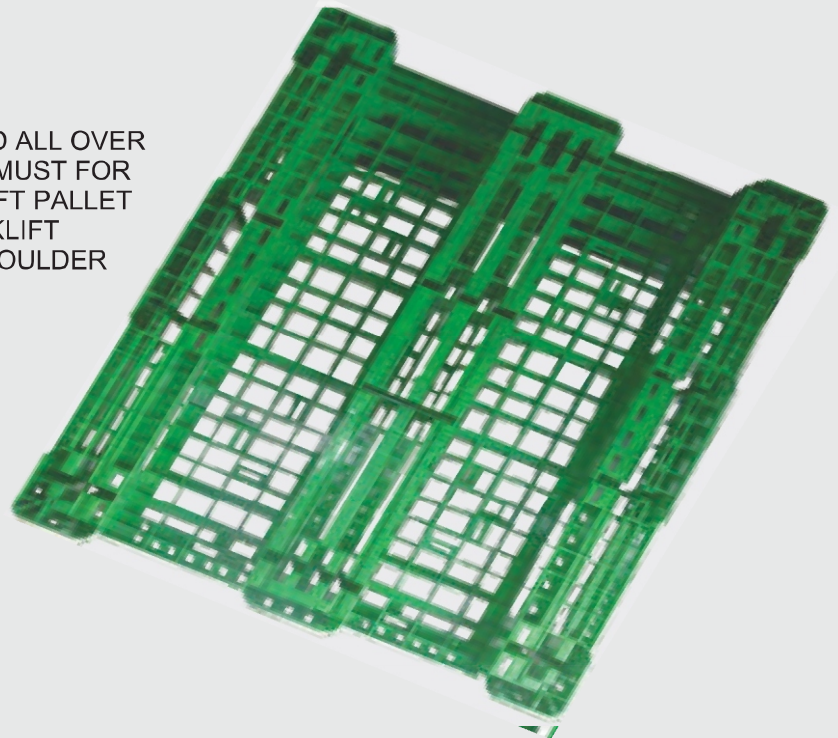

**BOTTOM**

LOAD SHOULD BE UNIFORMLY DISTRIBUTED ALL OVER THE SURFACE. STEEL REINFORCEMENT IS MUST FOR RACKING LOAD. IT IS RECOMMENDED TO LIFT PALLET FROM SHORT SIDE WITH JAW SIZE OF FORKLIFT ADJUSTED AT 685 mm. DO NOT THROW / SHOULDER DROP GOODS ON PALLET.



### ABBR. USED FOR PALLETS

- LW ▶ LIGHT WEIGHT
- MW ▶ MEDIUM WEIGHT
- HW ▶ HEAVY WEIGHT
- FT ▶ FLAT TOP

DIMENSION:	1200x1000x150mm.	MATERIAL	HDPE
STATIC LOAD	4000kgs.	4 WAY	 ✓
DYNAMIC LOAD	1000kgs.	2 WAY	 ✓
RACKING LOAD	600kgs.	METAL TUBE	✓

# PALLETS

## MODEL NO. 121015 LW



### TOP

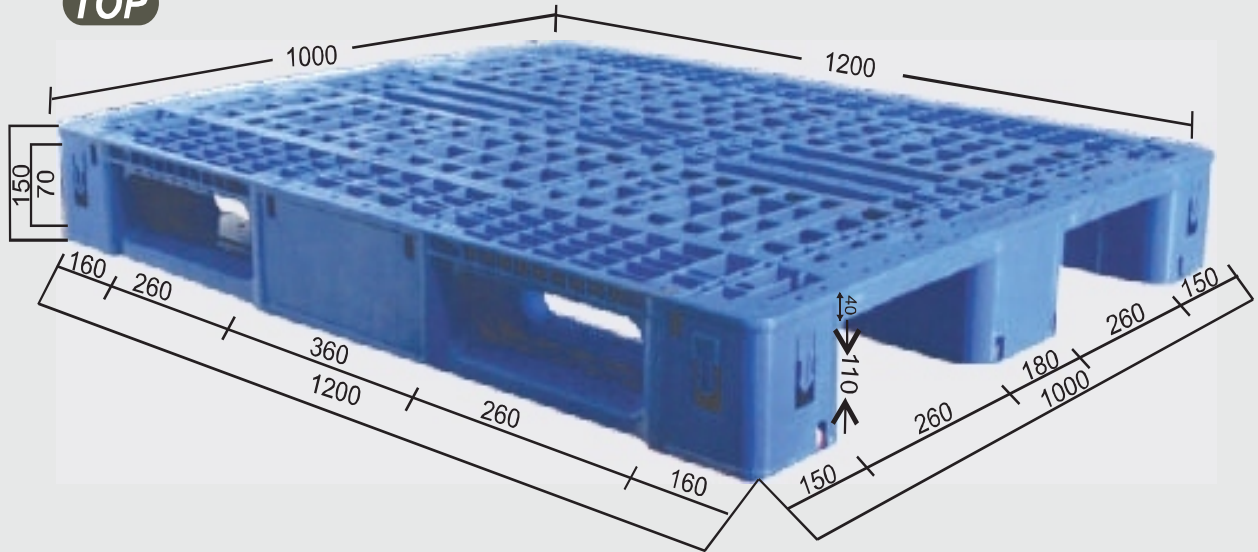

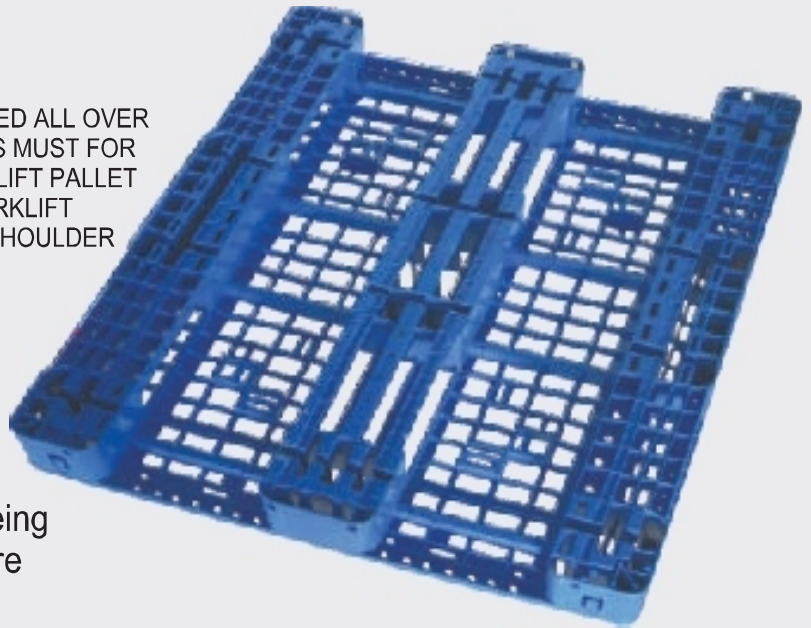

### BOTTOM

LOAD SHOULD BE UNIFORMLY DISTRIBUTED ALL OVER THE SURFACE. STEEL REINFORCEMENT IS MUST FOR RACKING LOAD. IT IS RECOMMENDED TO LIFT PALLET FROM SHORT SIDE WITH JAW SIZE OF FORKLIFT ADJUSTED AT 685 mm. DO NOT THROW / SHOULDER DROP GOODS ON PALLET.



#### Note.:

Static Load & Dynamic Load is being Calculated on Coverage of Entire Pallet Area.

DIMENSION:	1200x1000x150mm.	MATERIAL	HDPE
STATIC LOAD	2500kgs.	4 WAY	 ✓
DYNAMIC LOAD	800kgs.	2 WAY	 ✓
RACKING LOAD	N.A.	METAL TUBE	✓

# PALLETS



## MODEL NO. 121016 LW

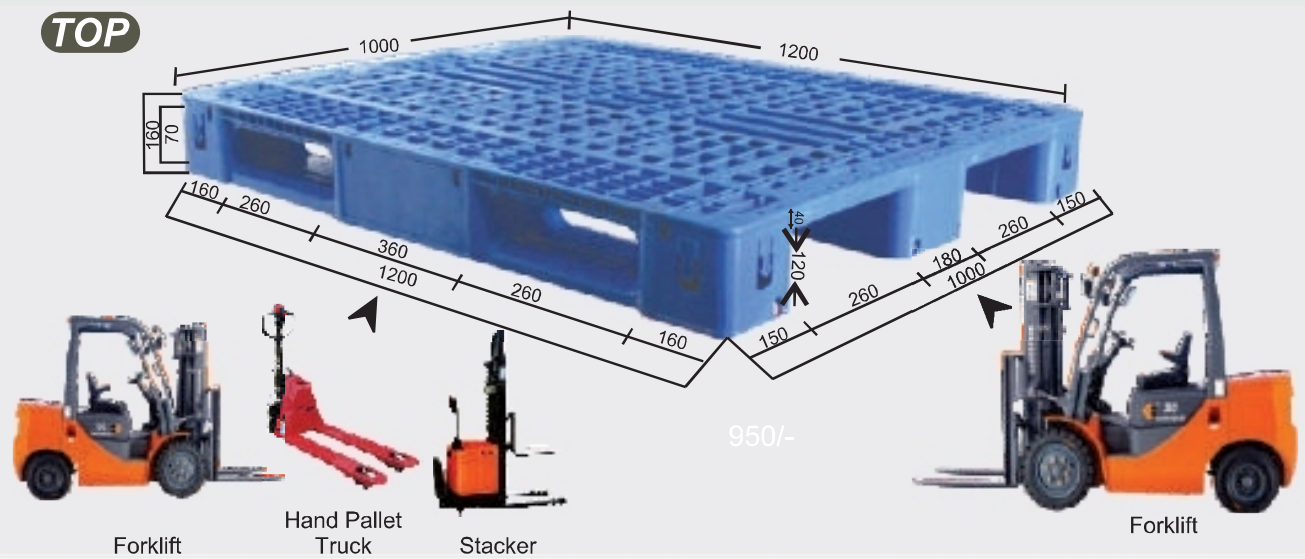

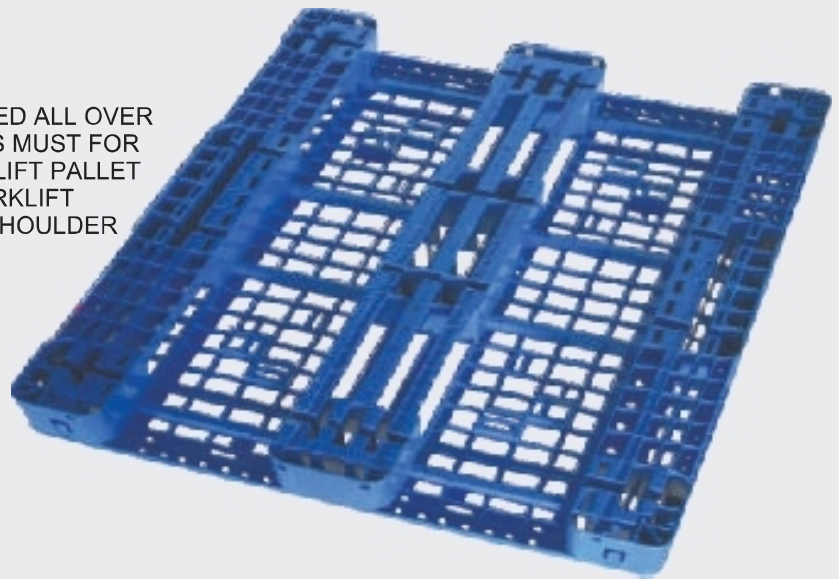

### BOTTOM

LOAD SHOULD BE UNIFORMLY DISTRIBUTED ALL OVER THE SURFACE. STEEL REINFORCEMENT IS MUST FOR RACKING LOAD. IT IS RECOMMENDED TO LIFT PALLET FROM SHORT SIDE WITH JAW SIZE OF FORKLIFT ADJUSTED AT 685 mm. DO NOT THROW / SHOULDER DROP GOODS ON PALLET.



### ABBR. USED FOR PALLETS

- LW ▶ LIGHT WEIGHT
- MW ▶ MEDIUM WEIGHT
- HW ▶ HEAVY WEIGHT
- FT ▶ FLAT TOP

DIMENSION:	1200x1000x160mm.	MATERIAL	HDPE
STATIC LOAD	4000kgs.	4 WAY	 ✓
DYNAMIC LOAD	1000-1200kgs.	2 WAY	 ✓
RACKING LOAD	700kgs.	METAL TUBE	✓

# PALLETS



## MODEL NO. 121014 L BLUE

PERFORATED & NESTABLE PALLET  
SPECIALLY DESIGNED FOR EXPORTS

TOP



Forklift



Hand Pallet  
Truck



Stacker

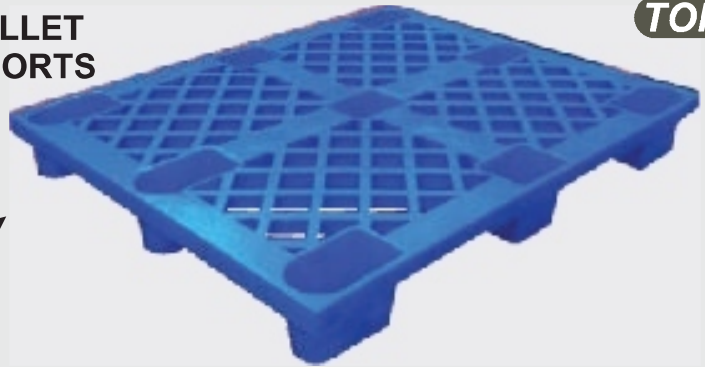

DIMENSION:	1200x1000x140mm.	MATERIAL	HDPE
STATIC LOAD	1500kgs.	4 WAY	 ✓
DYNAMIC LOAD	600kgs.	2 WAY	 ✓
LEGS	9 Leg	NESTABLE	✓
RACKING LOAD	N. A.	METAL TUBE	N. A.



## MODEL NO. 121014 L BLACK

BOTTOM

LOAD SHOULD BE UNIFORMLY DISTRIBUTED ALL OVER THE SURFACE. DO NOT THROW / SHOULDER DROP GOODS ON PALLET.



PERFORATED & NESTABLE PALLET  
SPECIALLY DESIGNED FOR EXPORTS

DIMENSION:	1200x1000x140mm.	MATERIAL	HDPE
STATIC LOAD	1200kgs.	4 WAY	 ✓
DYNAMIC LOAD	500kgs.	2 WAY	 ✓
LEGS	9 Leg	NESTABLE	✓
RACKING LOAD	N. A.	METAL TUBE	N. A.



**Steel Reinforcement  
Available In  
150 & 160 Series only.**

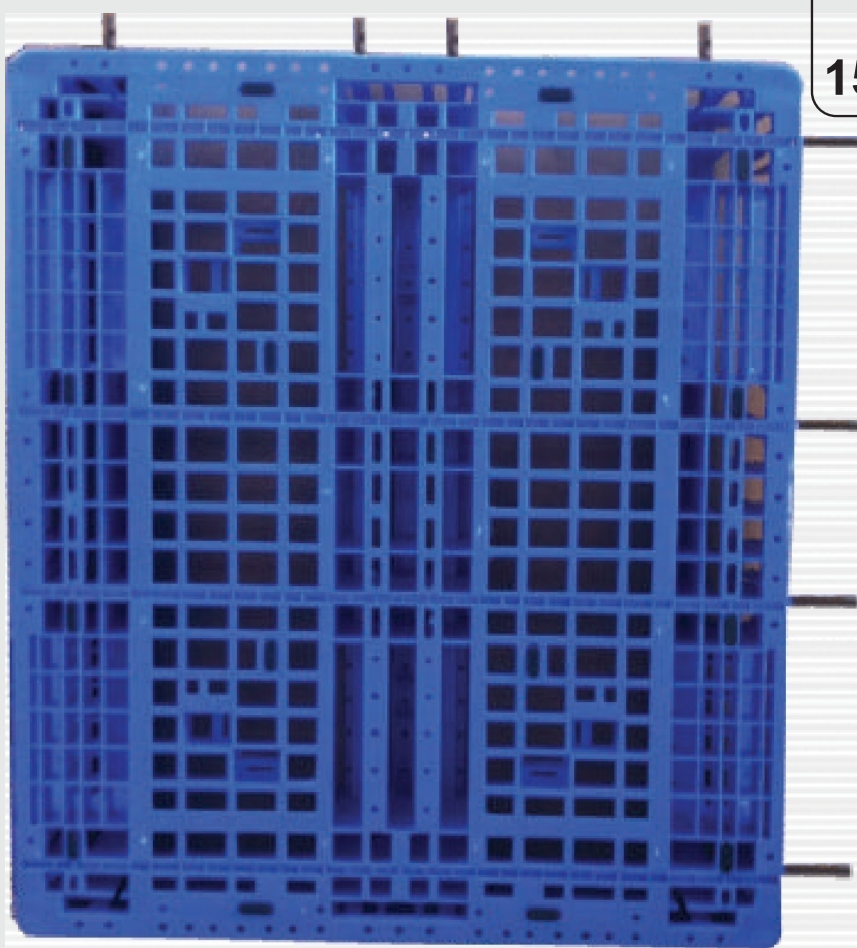

**Steel Reinforcement Enhancing the Load bearing Capacity  
Available in 121015 & 121016 Series.**

ICE BOXES



ICE BOX- 6 LTR.  
27 x 21.4 x 19 CM



ICE BOX-14 LTR.  
35 X 27.4 X 24 CM



ICE BOX 25LTR.  
38.5 X 37.5 X 30CM



PLUG

ICE BOX- 25 LTR WITH PLUG



ICE BOX- 50 LTR.  
62.5 x 36 x 35.5 CM



VENT LID

PLUG

**Ice Box 50 Ltr & 60Ltr also Available with vent lid & Plug**

# HAND PELLETE



Hydraulic Hand Pallet Truck  
Capacity: 2500kgs



Heavy Duty Hyd. Hand Pallet Truck  
Capacity: 3500kgs / 5000kgs

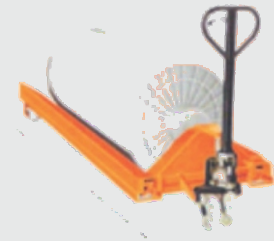

Hydraulic Beam Pallet Truck  
Capacity: 1000kgs / 3000kgs



Weighing Scale Pallet Truck  
Capacity: 1500kgs / 2000kgs



Battery Pallet Truck  
Capacity: 1500kgs / 2000kgs



High Lift Hand Pallet Truck  
Capacity: 800kgs / 1000kgs



Rough Terrain Pallet Truck  
Capacity: 1000kgs / 2000kgs



SS Hand Pallet Truck  
Capacity: 2000kgs / 2500kgs



SS Weighing Scale Pallet Truck  
Capacity: 2000kgs



Mobile Floor Crane  
Capacity: 1000kgs / 2000kgs



Electric Floor Crane  
Capacity: 1000kgs / 5000kgs



Battery Operate Floor Crane  
Capacity: 1000kgs / 5000kgs



# PP BOX

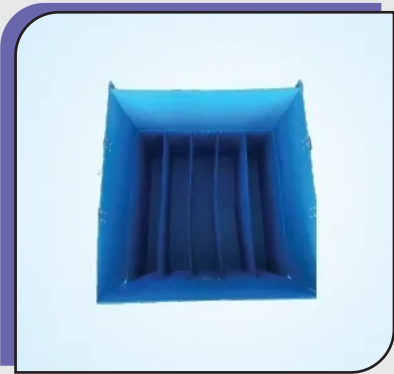
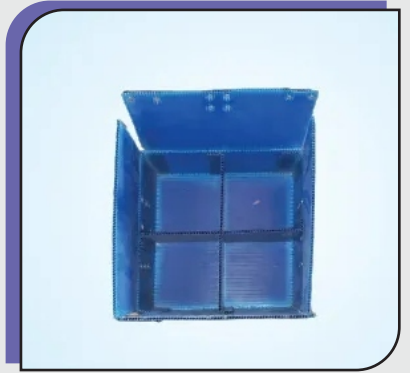
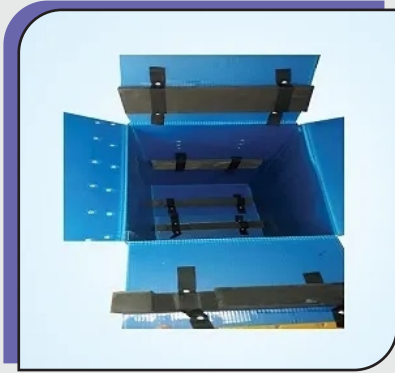

# PP BOX ACCESSORIES

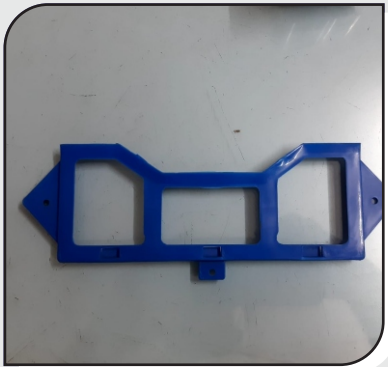
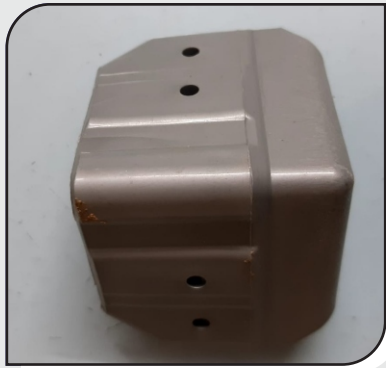
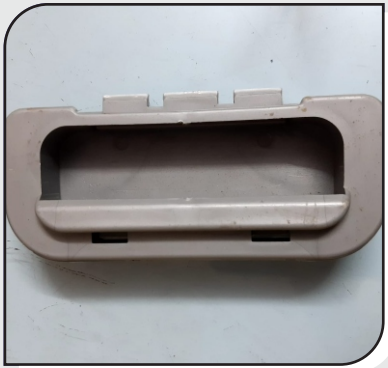



# EP FOAM

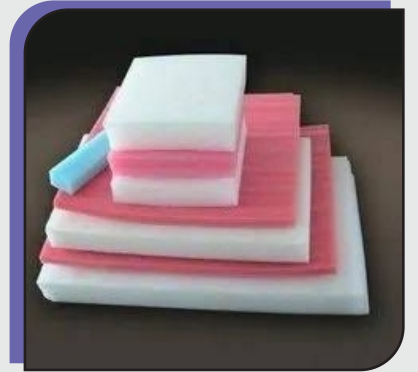
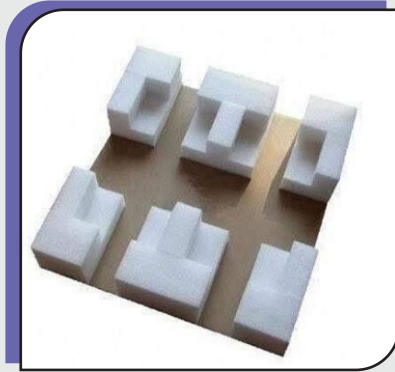
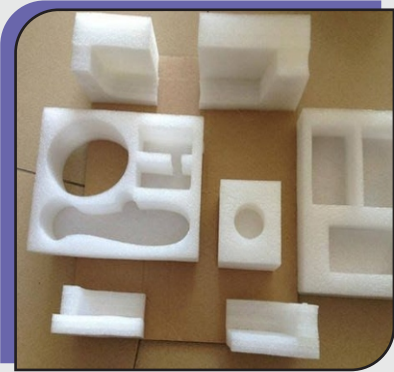

# RACKS



## ***Slotted Angle Racks***



***We manufacture and supply slotted angle racks of various dimensions and sizes as per the requirement of client. We offer facility of holes in such a way that panel of any size can be fitted and accordingly load can be managed.***

## ***Semi Light Duty Racks***



***We have achieved paramount success in manufacturing trading, wholesaling and supplying of Semi Light Duty Racks.***

# RACKS



## *All type of Mezzanine*



*Pillar Supported Mezzanine*



*Rack Supported Mezzanine*



## *Multi-Tier Mezzanine*

The industrial mezzanine system effectively increase the vertical space utilization of warehouse. Our multi-tier mezzanine are suitable for storing item in bulk like gunny bags, rolls etc. It is built keeping in mind simple integration properties which enable the designer or architect to create workspace, office or perform other value added activities.

Multi tire storage system offer the ultimate add-on floor and storage space that is much needed for storage houses. This is a complete system that has multiple shelves, rack and is equipped with stairs, floors, lifts, walkways etc.

# RACKS



## Cantilever Rack

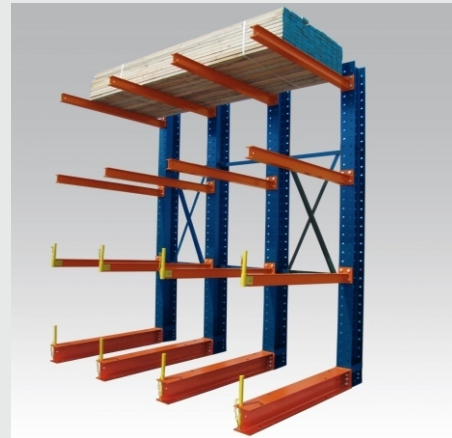

**Cantilever Rack**

**Cantilever Rack**

*Cantilever racks is an ideal storing systems that allows storage of longer, thinner, oversized, long loads and other items , like beam, length piece of lumber, Pre-Packed furniture and more, It can benefit your available space in many ways, and therefore, you should invest in the premium quality racks for easing your storage problems*

## Display Rack



**5M is the leading manufacturers in Supermarket display racks. Supermarket display racks typically consist of a flat base and a vertical component featuring notches, pegboards and slatwalls. The vertical piece can be fitted with shelves, hooks and other displays.**



# RACKS

## Cable Tray



## Mobile Compacter Racks



**Designed for use in places with limitation of space, those Mobile Compacter Rack choices are quality mobile racks that come with high storage capacity and are available in options of mechanical based systems. Finding suitability for all types of storage requirements, the racks are extensively used in areas like Factories, Public & Private Sectors, Banks, Hospital, Automobile Industries, s and similar other places.**

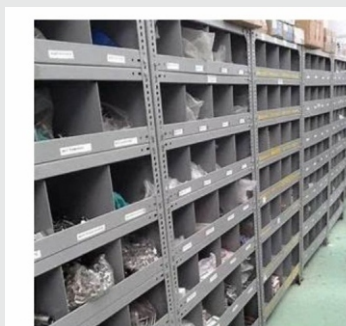

Pigeon Rack



File Rack



Employ Lockers

# RACKS



## Dia Rack



## FIFO RACK



Wire mess Trolley



(T)\*

M S Pallet



# VACCUME TRAY



## ANTI-STATIC BLISTER PACKAGING TRAY

High quality blister packaging tray.



## BLISTER PACKAGING FOR FROZEN GOODS

Best in class material , best suited for frozen goods..



## BLISTER TRAY FOR FOOD PRODUCTS

Premium finished packaging blisters for food products..



## CLAMSHELL PLASTIC BLISTER FOR FOOD

High quality blister packaging tray.



## CUSTOM WAX MELT BLISTER PACKAGING

Customized wax melt clamshell blister.



## CUSTOM WAX MELT BLISTER PACKAGING

Customized wax melt clamshell blister.



## CUSTOMIZED BLISTER PACKAGING FOR PLANTS

High quality blister packaging for plants.



## ESD PLASTIC BLISTER

Anti-static tray is a special packaging blister material.



## FOOD BLISTER FOR BISCUITS AND COOKIES

Premium finished packaging blisters best suited for food products like cookies and biscuit.



# VACCUM MOULD

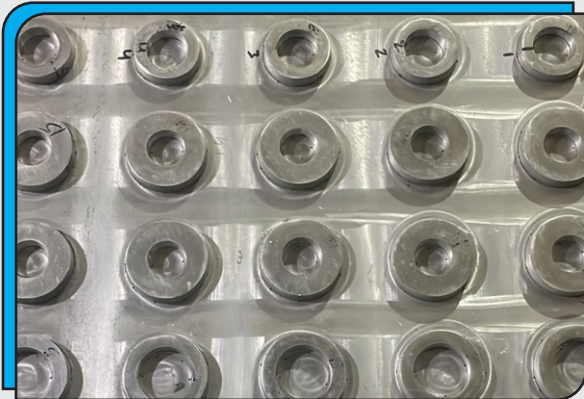

# PLASTIC MOULD

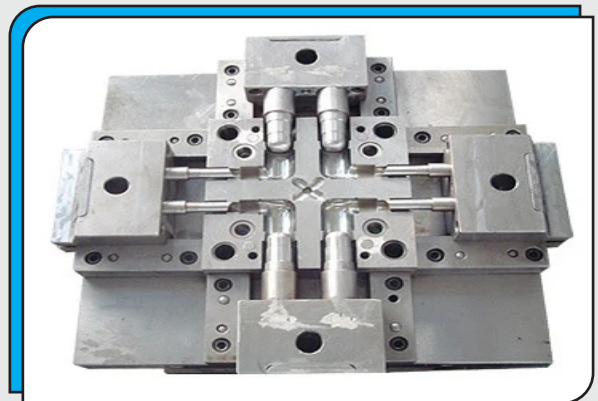
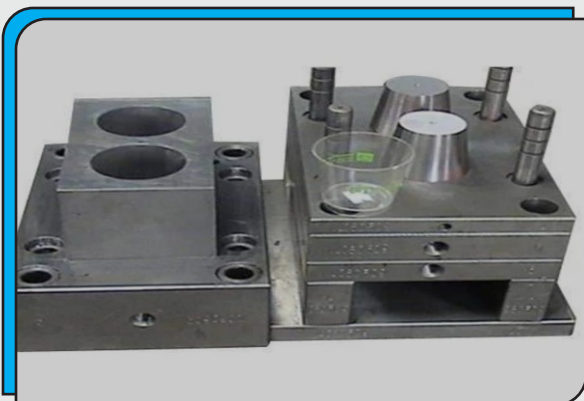
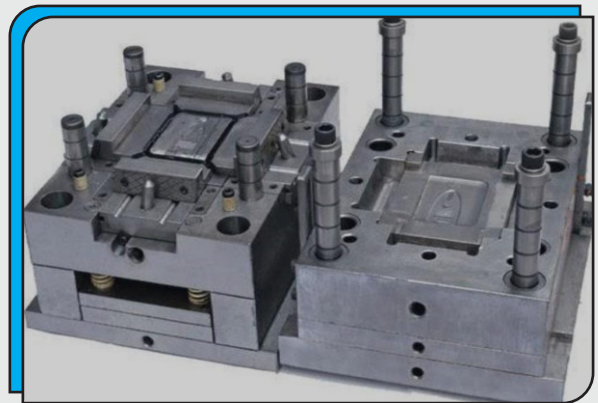
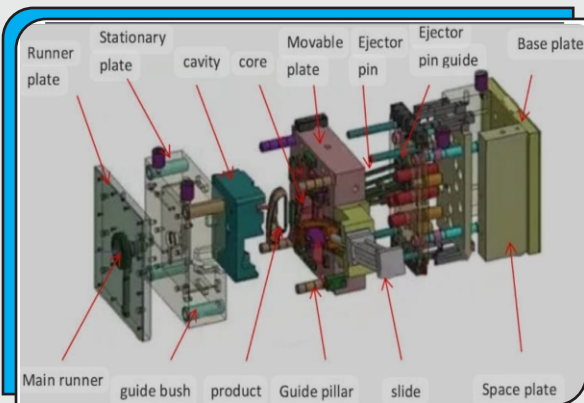



# AKSHRA INDUSTRIES

(An ISO 9001 : 2015 Co.)

Mfrs. of : Plastic Crates, Bins, Pallets, PP Boxes & Racks

Factory:

Plot No. 3, Gadpuri Industrial

Area, Near By NH-2,

Faridabad - 121004, Haryana

Mobile : +91-9821733080, 9311699257

E-mail : [industriesakshra@gmail.com](mailto:industriesakshra@gmail.com)

Office :

Plot No. 03, Rajesh Complex Unity City

Chauraha, Kanchana Bihar Marg,

Lucknow-226022